

OLD ADIRONDACK™ Inc.

Natural Cedar Furniture

NOTE: WHITE CEDAR

Eastern White Cedar is one of nature's most unusual woods, Because most cedar grows near swampy water basins, it has a slow rate of decay and a natural resiliency to rot and disease.

As it continues to dry and cure, Eastern White Cedar normally will check or develop the cracks that help create the wood's natural character. Also, while it continues to dry, Eastern White Cedar's natural wood oils may develop a dust on the surface of the wood, which is the crystallization of the wood oils. These are normal and natural processes in cedar and in no way affect the strength or durability of the furniture. This dust can be easily removed with a dry cloth.

Occasionally, cedar will warp slightly or check/crack during transportation, which is normal for natural cedar furniture. Most of the time, this does not impact the assembly or durability of the product.



#40 Potting Bench

Hand crafted in the USA

Thank you for purchasing this OLD ADIRONDACK™ Inc. furniture. Enjoy!

OLD ADIRONDACK™ Inc. uses Eastern White Cedar from the Adirondack Mountains that is carefully selected, harvested, and shaped. Fresh pale tan or light gold cedar has an odor that acts as a mild insect repellent and turns to a gray color over time. Water based or oil stains will delay the weathering process and latex paint coats evenly and lets the wood breathe. We ship it in its natural color. Some minor assembly is required. Hardware needed for assembly is included.

PLEASE READ ALL INSTRUCTIONS CAREFULLY BEFORE ASSEMBLY

Tools and Parts

Required Tools:



Hammer or Rubber Mallet



Wrench

Included Parts:

1 – Bench Top



1 – Bottom Shelf

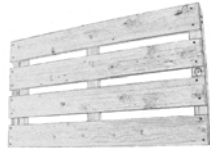

2 – Dowels



2 – Long Posts

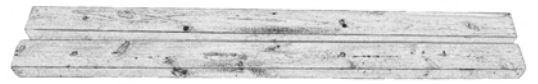

1 – Shelf

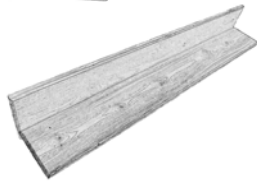

2 – Shelf Ends



2 – Short Posts



1 - Tapping board



Included Hardware:

- 8 – Bolts
- 8 – 3/8 ” Nuts
- 8 – 3/8” Washers



14 – 1-5/8” Screws



Other Garden Accessory Products

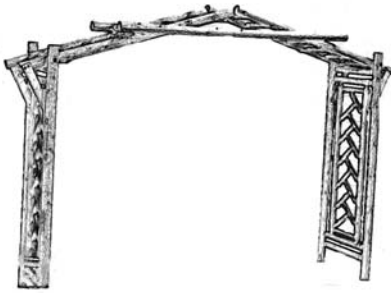

#447 –Adjustable Arbor



#121M – Garden Bench

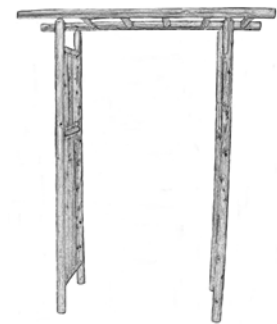

#440 – Small Arbor



#124T – Large Garden Table



#43/44 –Planter Set and Extension



#120M–Garden Chair

Facts and Suggestions for your cedar furniture

General

- Read each step carefully before starting. Make sure each step of instruction is performed in the correct order.
- Work in a spacious area. The shipping box may be used as a work surface after removing all staples.

Hammering and Nailing

- Eastern white cedar is a soft wood and may be damaged by striking it with a metal hammer, therefore use a rubber mallet OR a hammer with the included tapping board.



Care and Maintenance

- It is not necessary to finish or treat white cedar for outdoor use; it will slowly turn gray within 6-12 months and typically provides 15 - 25 years of service in its natural state.
- Sandpaper may be used on an unfinished product to smooth holes and remove stains or markings; we recommend 80-grit sandpaper for best results.

Appearance options

- You can achieve many different looks with white cedar all of which take advantage of its natural rot resistance and slight cracking. Light sanding before finish work is beneficial.
 - o Clear oil or solvent based wood preservatives and treatments can be used if you desire to hold to the original new milled wood appearance. This technique will require reapplication every 1-2 years.
 - o Gray transparent stains are available that duplicate the weathered cedar look immediately revealing the character of the wood.
 - o Semi-transparent stains in either oil or latex base can make the cedar appear to look like teak or oak etc. depending on the stain's color or they can introduce a washed color look. The grain of the wood and knots will be visible with this approach
 - o Opaque stains in either oil or latex base generate a painted look. A primer is beneficial, and multiple coats may be necessary to obtain total coverage.
 - o To obtain an antique look, begin by using opaque dark brown/gray stain with dense coverage. Then use other opaque color stains on top of the dark color to provide the desired color. Finally, sand and make wear spots on the finish color to allow the dark color to be seen creating the shabby "chic" old look.

Assembly

Step 1: Place the *Bench Top* and the *Bottom Shelf* on the ground. Line up a *Long Post* next to the sides, aligning the *Bolt* holes (align with the bottom hole for the *Bottom Shelf* and with the top hole for the *Bench Top*).

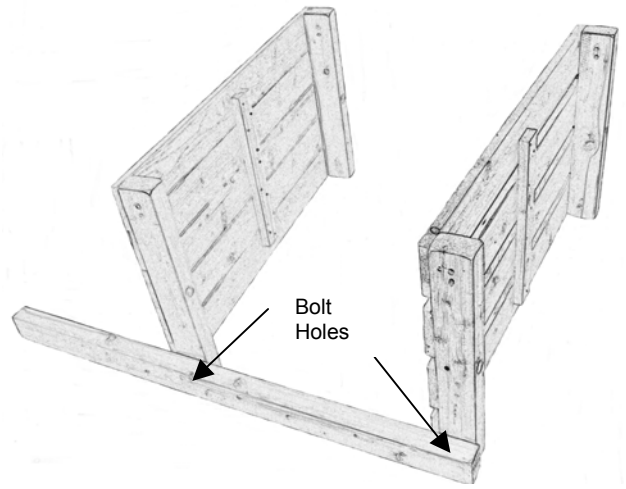

Insert the *Bolts*, lightly tapping with a *Hammer* if necessary. Place a *Washer* between the underside of the *Top/Shelf* and the *Nut*. Hand tighten the *Nut* only (you will tighten them all once the *Bench* is together). Repeat for the other *Long Post*.

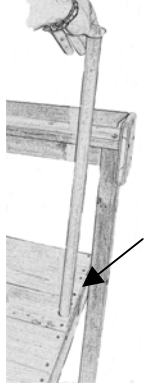
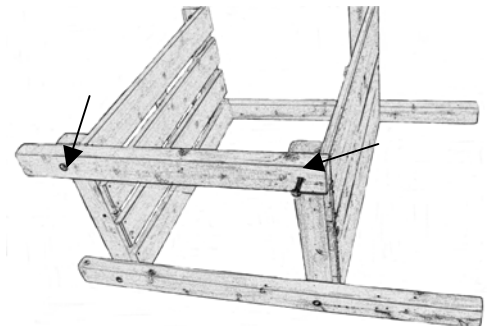
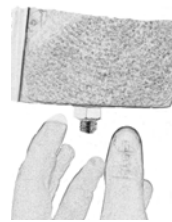
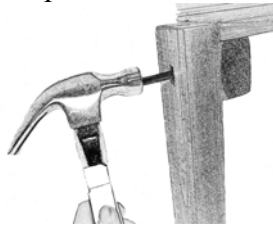
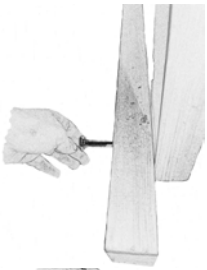

Step 2: In a similar fashion as in Step 1, Insert the *Bolts* in the *Short Posts*. Repeat for the other *Short Post*.

Step 3: Place the *Bench* upright on the ground, resting on the four (4) *Posts*. Insert the *Dowel* in the hole of the *Bench Top*, carefully aligning with the hole of the *Bottom Shelf* as you gently push the *Dowel* into place. Repeat for the other *Dowel*.

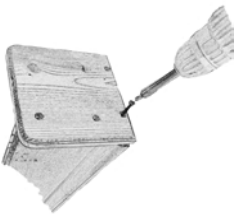
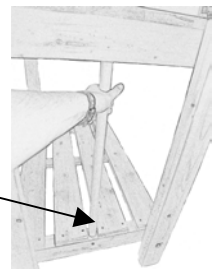

Step 4: Attach the *Shelf Sides* to the Shelf by aligning the flat side to the back of the Shelf ("L" part), with the curved end to the front and the pre-drilled screw holes to the outside. Lightly screw in the *Screws* with a *Screwdriver*; tighten after all *Screws* are in place lightly. Repeat for the other *Shelf Side*.

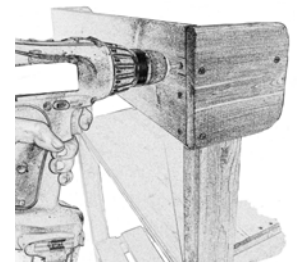

Step 5: Attach the *Top Shelf* by setting it on the *Long Posts* and inserting three(3) *Screws* on each side, aligning the *Posts* with the *Shelf*.

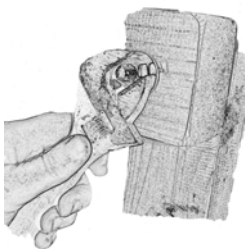

Step 6: Tighten *Bolts* and *Nuts* firmly using a *Wrench* or socket wrench. Do not over-tighten.



Enjoy your Potting Bench!

Five (5) Year Limited Warranty

All of **OLD ADIRONDACK's** Furniture comes with a manufacturer's five (5) year limited warranty. If any piece of furniture is proved to be defective by reason of improper workmanship and/or material we will replace, at our discretion, that part or the whole product at no charge to you or your customer. To obtain warranty service, either the consumer or the dealer must deliver the part in question or the entire product to the address below at their expense. A copy of the original sales receipt is appreciated when requesting warranty work. This warranty does not cover defects caused by: modification, alteration or repair of the enclosed product by anyone other than **OLD ADIRONDACK™ Inc.** This warranty also does not cover return shipment of the product to Old Adirondack. Write to Old Adirondack, PO BOX 663, Willsboro, NY 12996 or call at 800-342-3373 to obtain answers to any questions regarding this warranty.

OLD ADIRONDACK™ Inc. Products

Adirondack

#66 Adirondack Chair
#66S Adirondack Chair with Shelf
#80 Folding Adirondack Chair
#80C Child's Adirondack Chair
#82 Adirondack Footrest
#95 Adirondack End Table
#198 Curved Back Folding Adirondack Chair
#280 Adirondack Settee
#281 Adirondack Glider
#398 deStijl Adirondack Chair
#398C Child's deStijl Adirondack Chair
#801 Adirondack Rocker
#901 Curved Back Adirondack Rocker

Hearth & Porch

#24 Rocker
#24FB Flag Rocker
#27 Rocker Settee
#28 Settee
#55 Porch Swing
#GP Grilling Planks (S/L)

Garden

#120 Garden Chair (spindles/slat back/pattern)
#121 Garden Bench (spindles/slat back/pattern)
#122 Small Garden Table (regular/pattern)
#124 Square Table (regular/pattern with opt. Shelf)

Garden Accessories

#40 Potting Bench
#42 Planter Box
#43/43A Planter Set (with opt. Accessory Set)
#44 Planter Extension Kit
#39 Tree Bench(36"/24")
#39B Tree Bench Back (36"/24", regular/slat back)
#440 Garden Arbor
#445/445X Pergola/Extension
#447TM Adjustable Arbor

Pets

#500 Dog Beds (S/M/L with Green/Blue Mattress)
#540 Dog Feeder (S/L/Tall)

Living

#21 High Back Chair
#22 Footrest
#103/4/5 Bookcase (S/M/L with opt. Connectors)
#125TA Sofa Table
#201 Cushioned Chair
#202 Cushioned Loveseat
#203 Cushioned Sofa

Dining

#12 Small Bench
#18 Round Table, 48" (regular/umbrella)
#51 Square Table, 36"
#86 Side Chair
#131 Long Bench
#132 Rectangular Table
#133 Dining Chair (spindles/slat back, opt. Armless)

Bedroom

#170/171 Slat Back Pattern Bed (T/D/Q/K, canopies)
#180/181 Slat Back Bed (T/D/Q/K, canopies)
#190/191 Slat Back Sleigh Bed (T/D/Q/K, canopies)
#270B Daybed
#270/271 Straight Spindle Bed (T/D/Q/K, canopies)
#370/371 Pattern Bed (T/D/Q/K, canopies)
#375/376 "T" Pattern Bed (T/D/Q/K, canopies)
#470/471 Rustic Pattern Bed (T/D/Q/K, canopies)
#970 Straight Spindle Headboard Only (T/D/Q/K)
#975 Pattern Headboard Only (T/D/Q/K)
#71 Nightstand with 1 Drawer and 1 Shelf
#712 Nightstand with 2 Shelves
#72 Dresser – 3 Drawer
#721 Dresser – 1 Drawer and 1 Shelf
#722 Dresser – 6 Drawer
#73 Dresser – 5 Drawer
#77 Quilt Ladder
#78 Bed Bench
#79/79T Mirror (regular/pattern)

OLD ADIRONDACK™ Inc.

19 Myers Way PO Box 663 Willsboro, NY 12996